

MDI. DT. MRB. 10

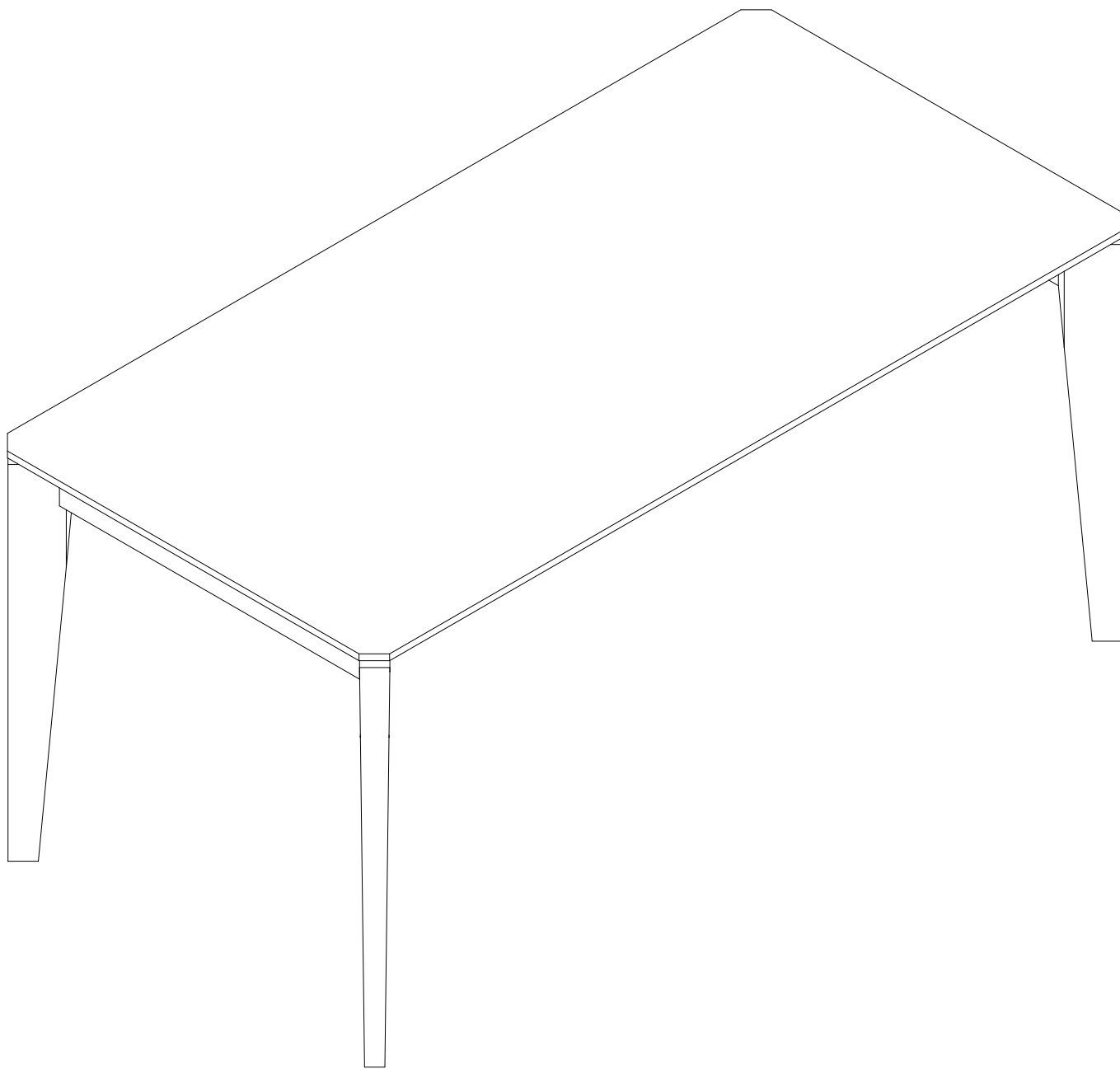

**EAC**

# MDI. DT. MRB. 10

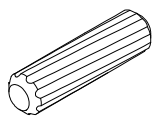
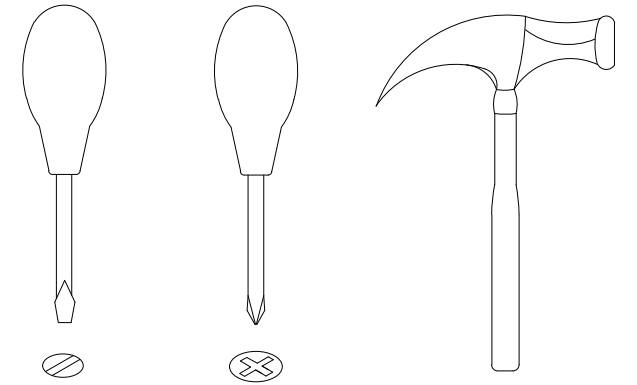
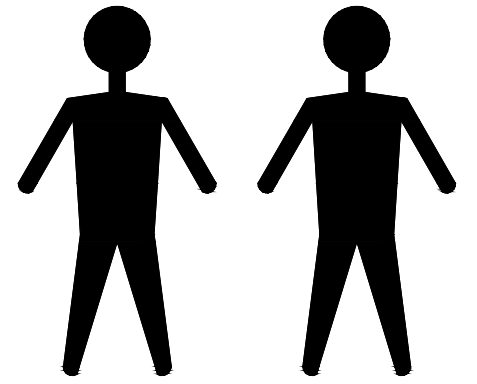

A x8  
Spec:  $\phi 8 * L30$

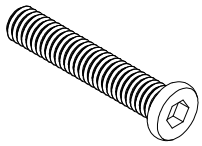

C x12  
Spec: 5/16\*45



D x12  
Spec:  $\phi 8 * \phi 14$

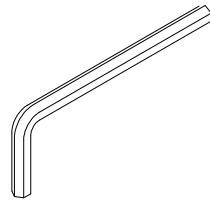

E x1  
Spec: 5#

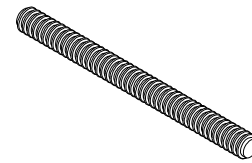

F x4  
Spec: M8\*L95

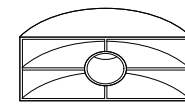

G x4  
Spec:

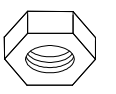

H x4  
Spec: M8

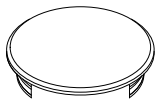

I x4  
Spec:  $\phi 38$

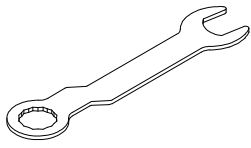

J x1  
Spec: 14#

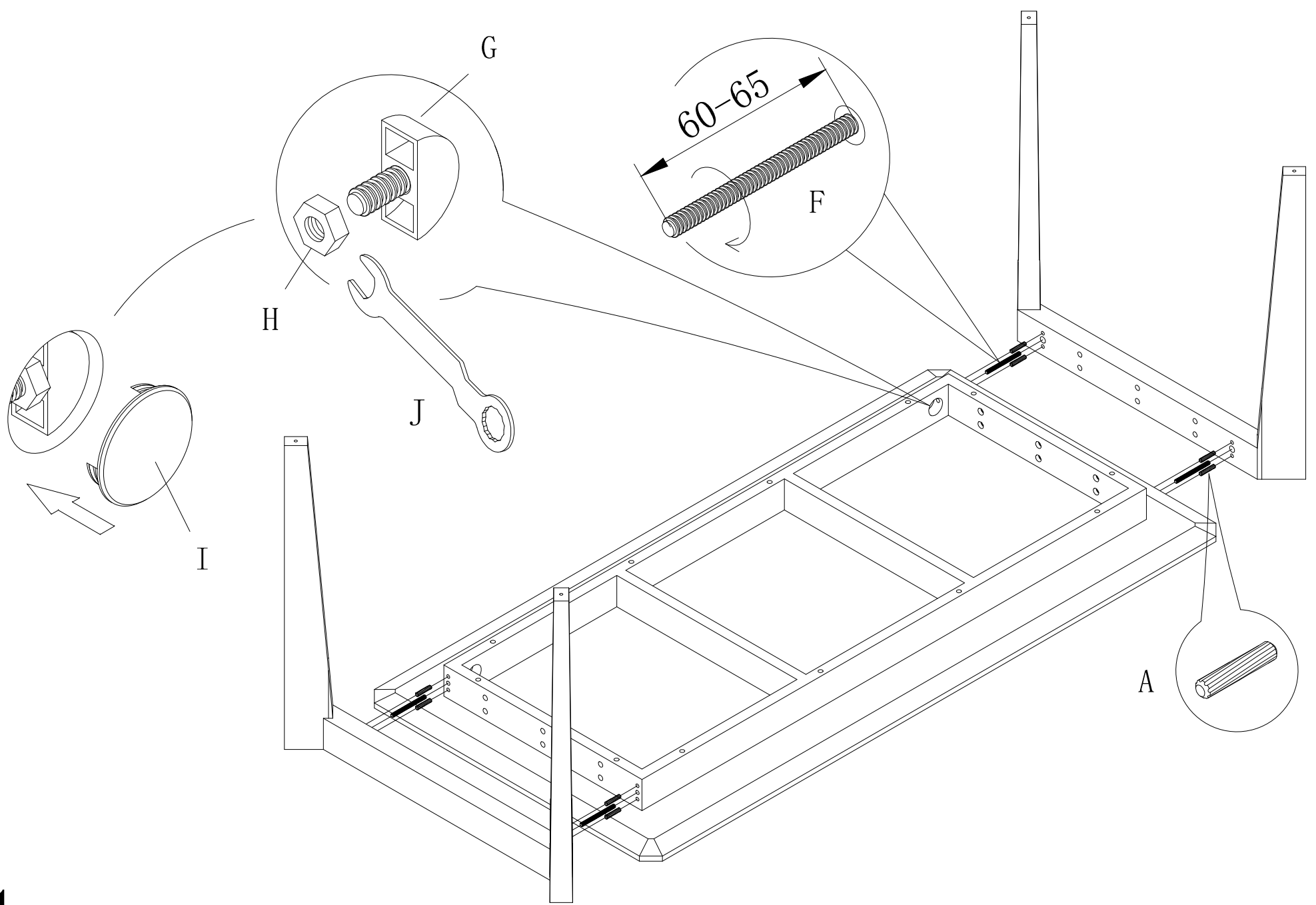

2

