

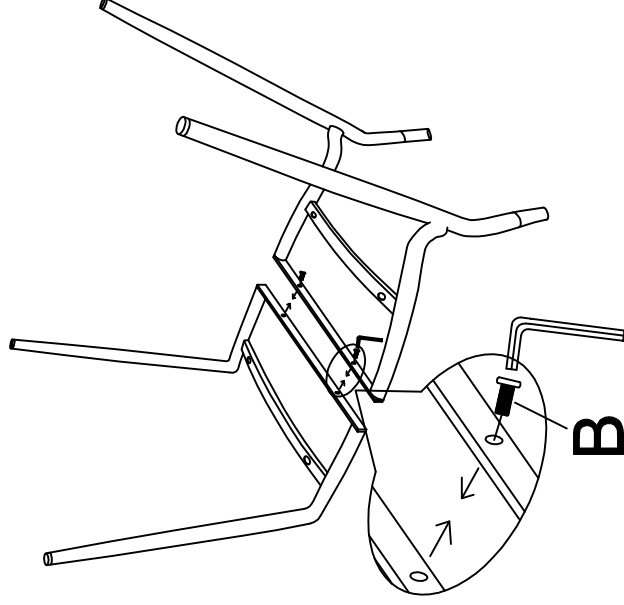

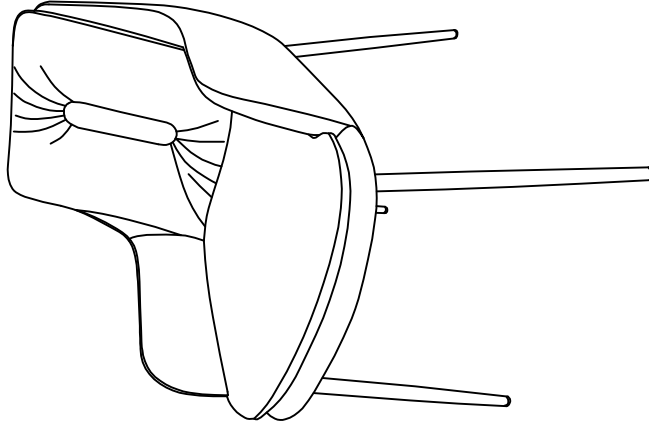

Step:1

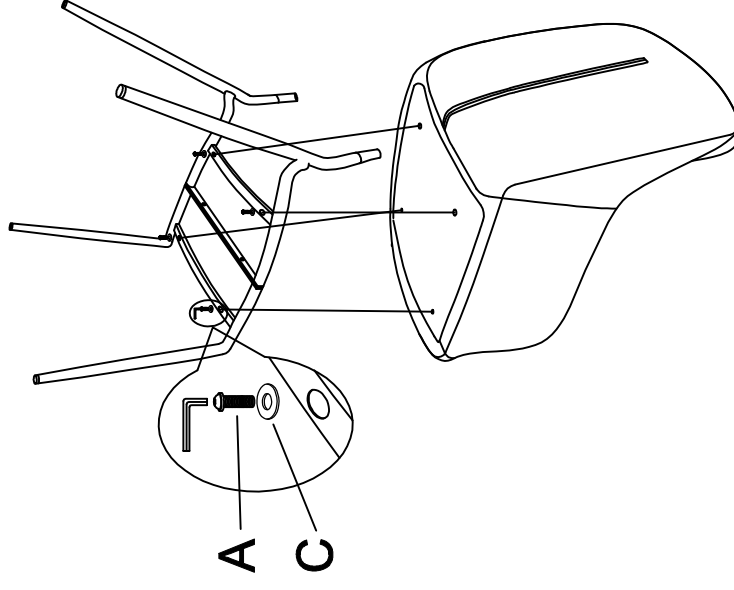

Step:2



Finish

A		x4
B		x2
C		x4



x1



0:10

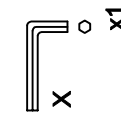

x1