

20.21.1318.00

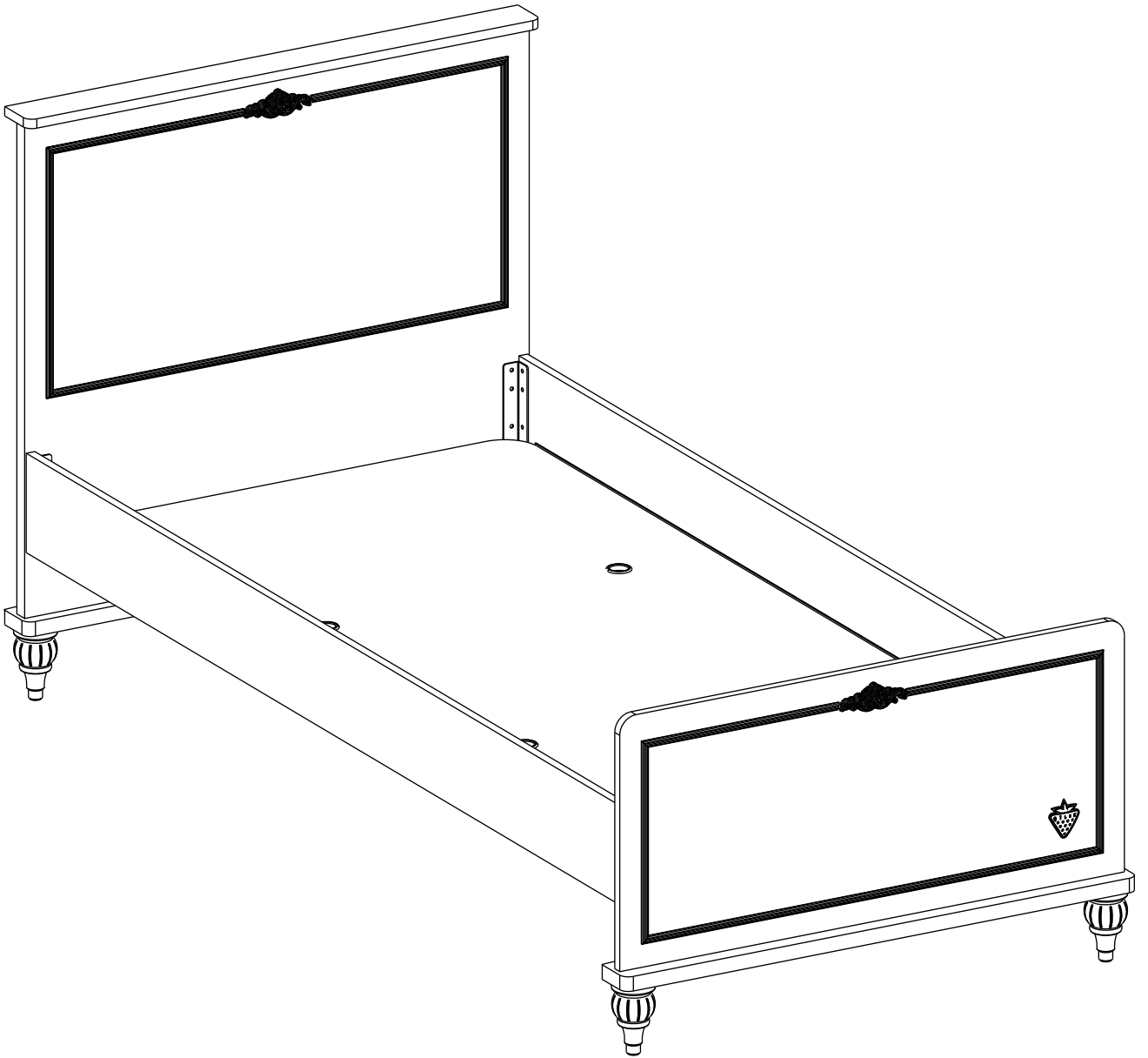

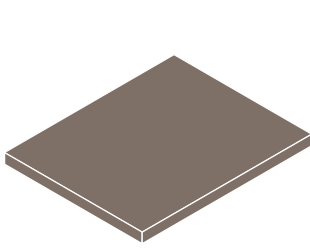

3 / 1

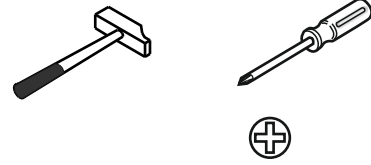
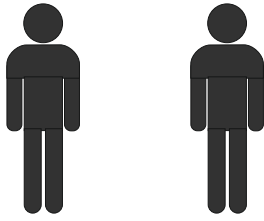
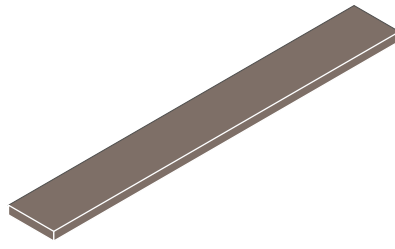

3 / 2

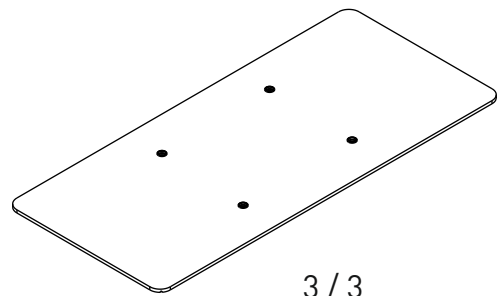

3 / 3

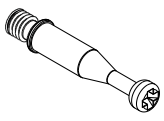

13.07.01.108 x 4

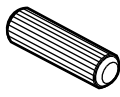

13.01.01.111 x 18



13.02.01.017 x 30



13.07.01.110 x 4

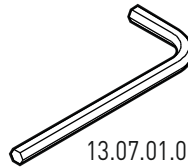

13.07.01.016 x 1

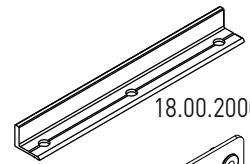

18.00.2000.208 x 2

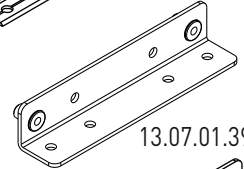

13.07.01.398 x 2

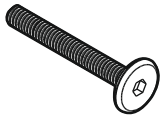

13.03.01.039 x 8
M6X55



13.03.01.034 x 4



13.07.01.287 x 8



13.03.01.021 x 28



13.01.01.045 x 4



13.03.01.027 x 4
M6X25

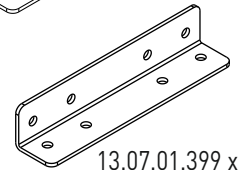

13.07.01.399 x 2

3 / 1

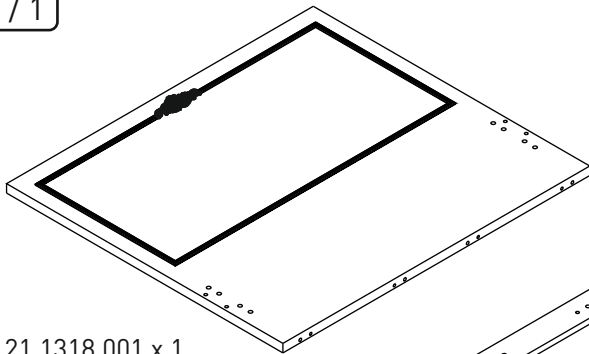

18.21.1318.001 x 1



13.01.01.293 x 4

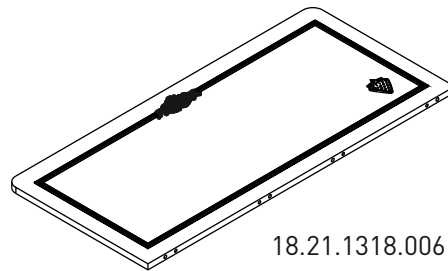

18.21.1318.006 x 1

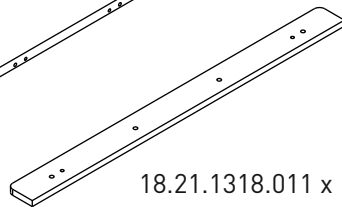

18.21.1318.011 x 1

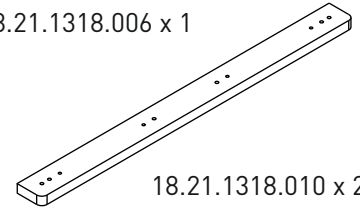

18.21.1318.010 x 2

3 / 2

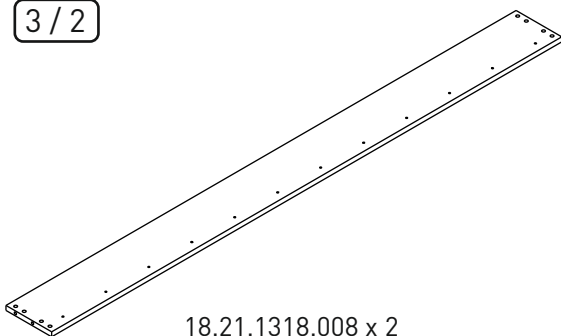

18.21.1318.008 x 2

3 / 3

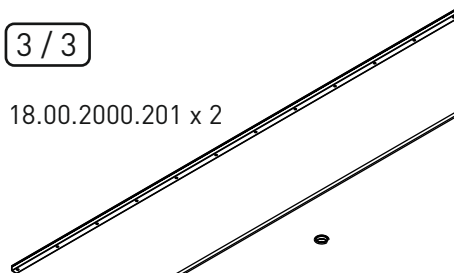

18.00.2000.201 x 2

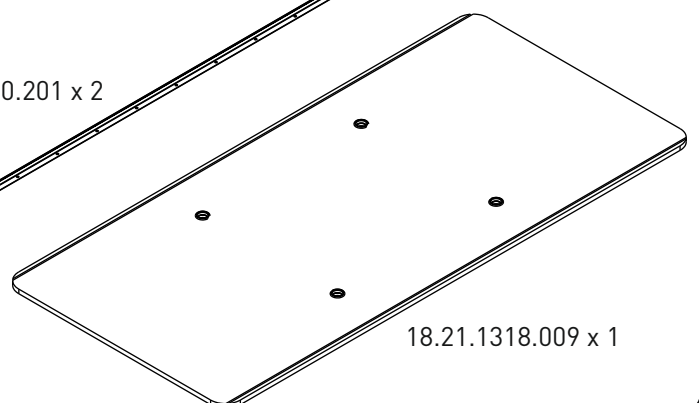

18.21.1318.009 x 1

1

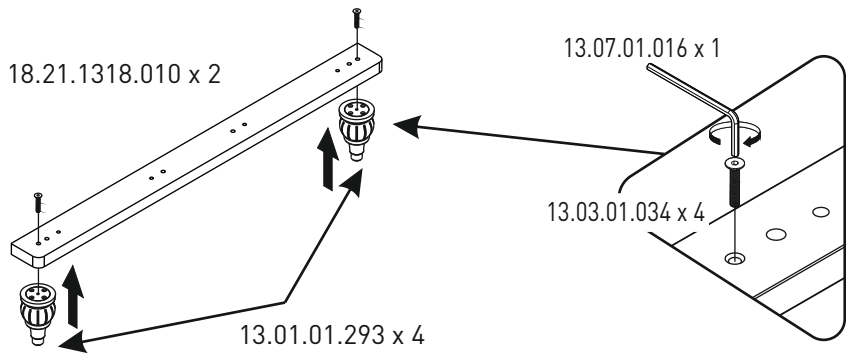

2

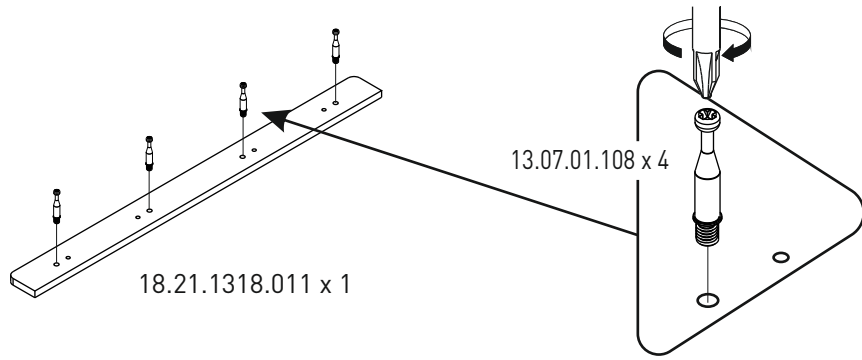

3

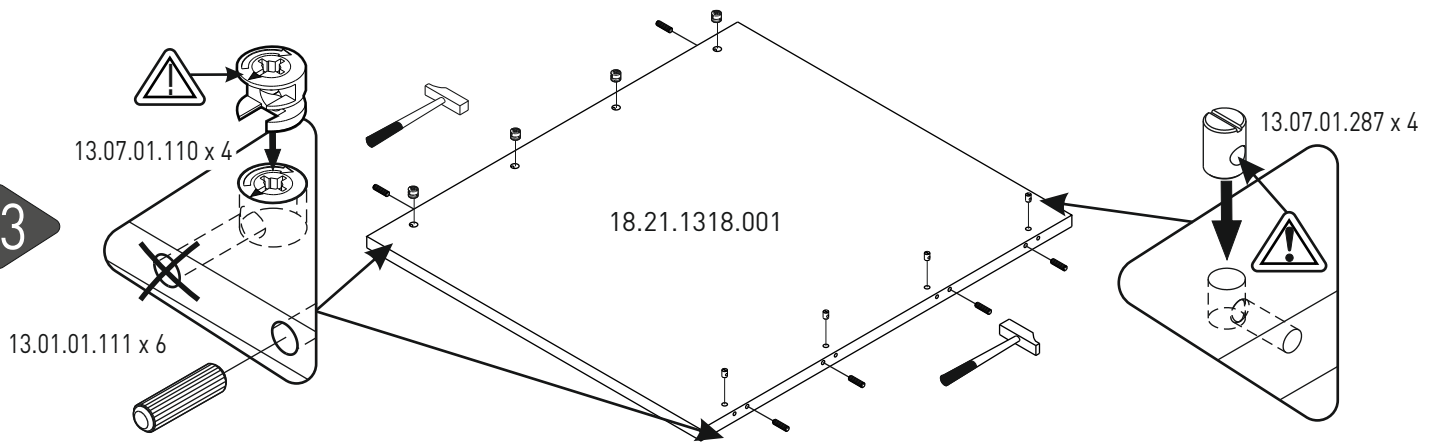

4

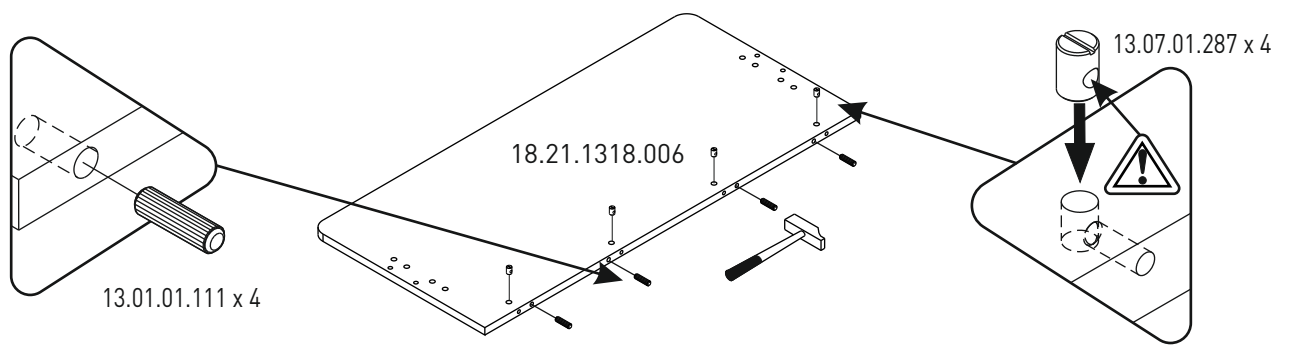

5

